



LNG INFORMATION PAPER

#2

2019 Update

The LNG Process Chain

contents

About LNG	01
The LNG Process Chain	02
Production: Extraction of the Natural Gas	02
The Natural Gas Liquefaction Plant	02
LNG Transportation	03
LNG Receiving and Regasification Terminals	04
Key Points and Conclusions	08

GIIGNL's Technical Study Group introduces a series of Information Papers that provide factual information about Liquefied Natural Gas (LNG). This paper summarizes the components of the "LNG Process Chain" - the steps and industrial processes used in producing, storing, and delivering LNG to customers. LNG is used to transport natural gas economically from distant locations to consumers and to provide diversity and security for the gas supply.

ABOUT LNG

Liquefied natural gas is natural gas, primarily composed of methane, which has been converted to liquid form for ease of storage and transport. LNG takes up about 1/600th the volume of natural gas. The conversion of natural gas to its liquefied form allows for the transport of greater quantities. Liquefaction describes the process of cooling natural

gas to approximately -162°C (-259°F) until it forms as a liquid. LNG must be turned back into a gas for commercial use and this is done at regasification plants. This Information Paper describes the process used to produce and ultimately deliver LNG to consumers. This process is known as the LNG Process Chain.

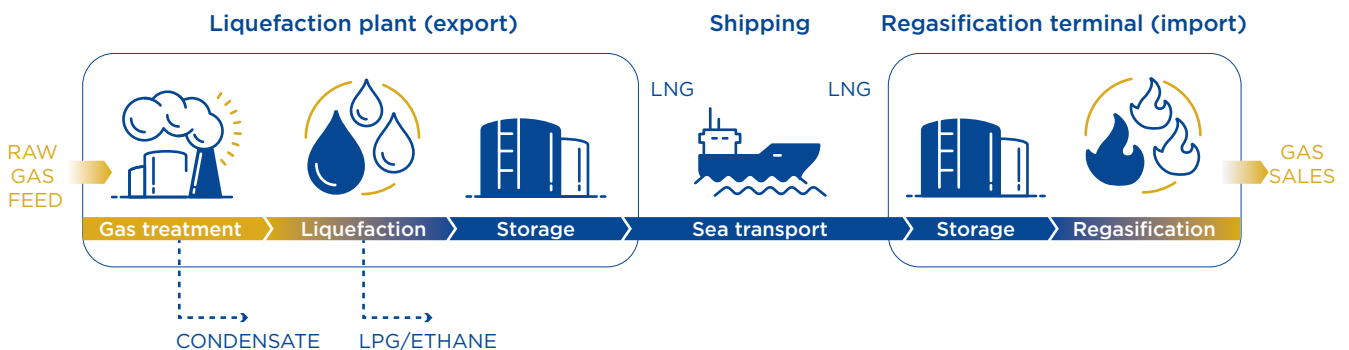

Figure 1. The LNG Process Chain



THE LNG PROCESS CHAIN

Since 1964, LNG production, export, import and distribution has followed a process sequence similar to that illustrated in **Figure 1**. Furthermore, LNG is currently transported by trucks with specially designed tanks for LNG

from import terminals to end-users. It is also used as a fuel for vehicles and ships in liquid form as illustrated in **Figure 2**.

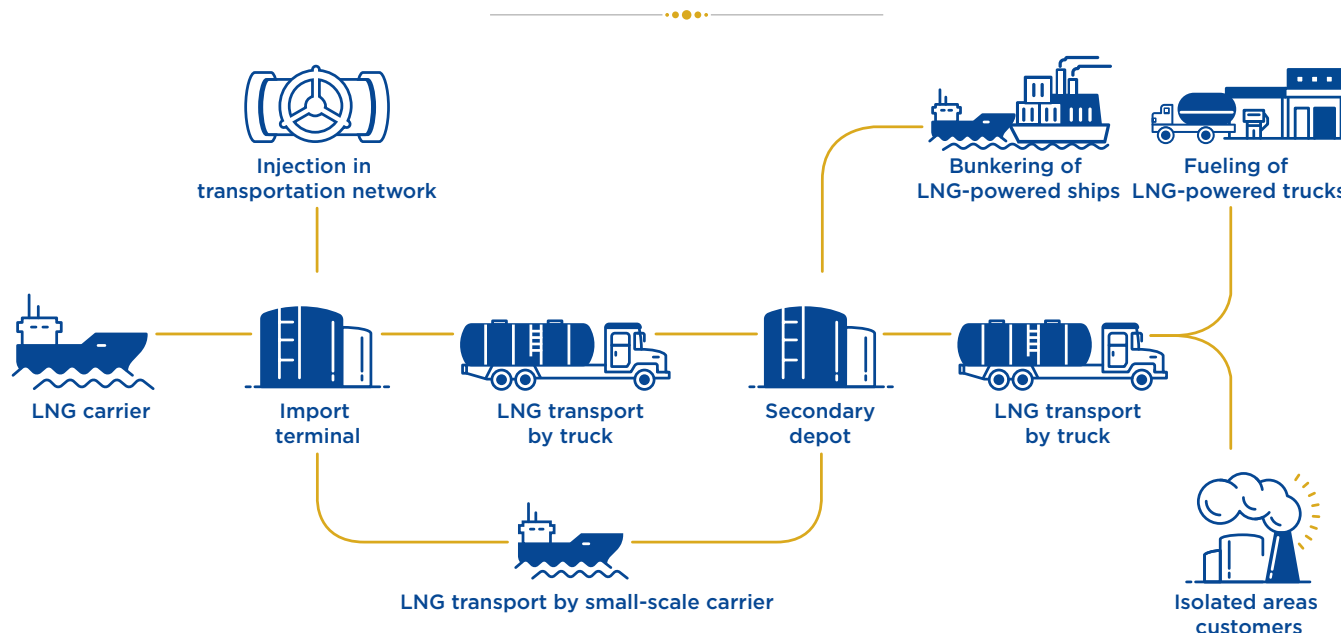

Figure 2. The Small-Scale LNG Value Chain (Source: Snam 2018, <http://www.snam.it/>)

PRODUCTION: EXTRACTION OF THE NATURAL GAS

Extraction of the natural gas from beneath the earth’s surface is the first step along the process chain.

A majority of the world’s LNG supply is exported from countries with large natural gas reserves (20 countries with a total nameplate capacity for liquefaction of 406 MTPA at the beginning of 2019). These countries include Algeria, Angola, Cameroon, Egypt, Equatorial Guinea, Nigeria, Norway, Trinidad & Tobago, USA, Oman, Qatar, UAE, Yemen, Australia, Brunei, Indonesia, Malaysia, Papua New Guinea, Peru and Russia. Other countries may produce natural gas for domestic use but lack adequate supply to export on a large scale. In situations in which domestic gas supply is inadequate to meet intra-country demand, LNG is imported.

Once a potential natural gas field has been located by a team of exploration geologists and geophysicists, a team of specialists drills down to where the natural gas is thought to exist. After a well has been drilled and the presence of commercially-viable quantities of gas has been verified, the next step is to extract the natural gas (and/or oil) out of the ground and process it. At this point, the natural gas which is extracted from the ground is called “feed” gas. Before a commercial market for LNG existed, the gas associated with oil went unused and was wasted in a flare. Now it can be used as LNG.

It is important to emphasize that raw natural gas has to be purified before we can use it in our homes and factories. The natural gas we use as consumers is almost entirely methane, although natural gas is associated with a variety of other compounds and gases (e.g., ethane, propane, butane, pentanes, hydrogen sulphide [H₂S], carbon dioxide [CO₂], helium and nitrogen), as well as oil and water, which must be removed during production prior to liquefaction.

THE NATURAL GAS LIQUEFACTION PLANT

Step two in the process chain is cleaning the natural gas at the liquefaction plant. A series of processing steps allows the separation and removal of the various extraneous compounds from the natural gas prior to liquefaction.

Gas Treatment

One of the primary purposes of the liquefaction plant is to provide consistent composition and combustion characteristics through the cooling and condensing of the natural gas so it may be loaded as LNG on tankers (ships or trucks) and delivered to the end user. The combus-



tion characteristics and content consistency are critically important to obtain pipeline-quality gas. Pipeline-quality natural gas typically contains 85% to 99% methane. It also contains the heavier hydrocarbons and other substances which are not removed during the processing. **Figure 3** provides a summary of the stripping process that is used to remove many of the compounds present in the feed gas as it comes out of the ground, prior to beginning the liquefaction process.

More specifically, carbon dioxide and water are extracted upstream of liquefaction, otherwise they would cause damage to liquefaction facilities by freezing. Hydrocarbons heavier than methane are sometimes also separated and sold as raw materials to the petrochemical industry or used as fuel.

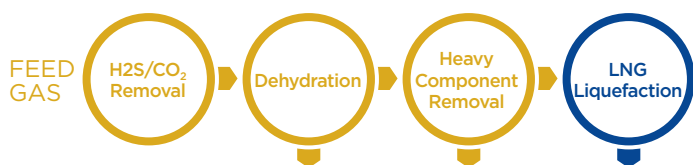

Figure 3. The production process flow for natural gas prior to liquefaction

Liquefaction

Following the removal of most contaminants and heavy hydrocarbons from the feed gas, the natural gas advances within the facility to undergo the liquefaction process. The natural gas being converted to its liquefied form is almost entirely methane at this point. To obtain maximum volume reduction, the gas has to be liquefied through the application of refrigeration technology which makes it possible to cool the gas down to approximately -162°C (-259°F) when it becomes a liquid.

At that point, LNG is a non-corrosive liquid that is clear and colourless like water, but weighs about half as much as the same volume of water. One volume of LNG equals approximately 600 volumes of natural gas at standard temperature (15.6°C/60 °F) and atmospheric pressure. Stated a different way, the liquid form occupies a volume 600 times smaller than the same amount of natural gas. It is this ratio of liquid to gas that makes LNG economically attractive for transport in bulk volumes by ship or truck.

LNG TRANSPORTATION

Step three in the LNG process chain is transporting the liquefied natural gas to the consumer. Primary modes are by sea and truck and in a few locations (e.g. Japan) by rail.

By Sea

When LNG is to be transported any great distance, it is most often transported by sea in specialized LNG carriers.

The first voyage of the MV Methane Pioneer in 1959 was from Lake Charles, Louisiana, to Canvey Island, United Kingdom. Commercial voyages began in 1964 on the MV Methane Progress and MV Princess from Algeria to Canvey Island. Safety systems on LNG carriers and the training of the crews that operate the vessels have evolved by a process of continuous improvement and are extremely robust. Almost 100,000 voyages have been completed without an incident which resulted in a loss of cargo.

Today, LNG is transported in large quantities and long distances on double-hulled ships specifically designed to contain the cargo at or near atmospheric pressure at a cryogenic temperature of approximately -162°C (-259°F) (**Figure 4**). LNG carriers are a blend of conventional ship design with specialized materials and advanced systems for handling cryogenic cargoes. The containment tanks have layers of insulation which isolate the LNG cargo from the hull by ensuring a minimum distance from the sides and bottom of the hull per the IGC (IMO International Gas Code) and add layers of protection in the event of grounding or collision. LNG Ships are described in more detail in **Information Paper No. 3**. LNG can be also transported in smaller quantities by ocean going as small as 1,000 cubic meters.

Additionally, this insulation system limits the amount of LNG that boils off or evaporates during the voyages. On many LNG vessels, boil-off gas is used to supplement fuel during the voyage.

There are stringent international regulations regarding the construction and operation of LNG Carriers at sea and in port. The International Maritime Organisation (IMO) is the



Figure 4. Examples of LNG carrier types: membrane design (top); Moss sphere design (bottom)



agency of the United Nations responsible for adopting and updating international treaties (called conventions) for shipping safety and security. IMO has adopted approximately numerous conventions and protocols, including the International Code for the Construction and Equipment of Ships Carrying Liquefied Gases in Bulk (IMO Gas Code) and the International Maritime Dangerous Goods Code.

By Truck

In areas around the world where a liquefaction plant is in the vicinity of regasification facilities, the most cost-effective transportation mechanism for LNG is by tank truck. Using specialised, double-skinned tank trucks, liquefied natural gas can be transported to a satellite plant (small regasification facility, bunker stations.) quickly and effectively. In many parts of the world, trucking has been used for the transportation of LNG since 1968. LNG trucking is now a mature industry, using tanker trucks of 6 to 20 tonnes which meet industry requirements. LNG is regularly transported by tank truck in all regions of the world, including but not limited to Chile, Dominican Republic, the US, China, Japan, South Korea, India, Indonesia, Spain, Turkey, Portugal, France, the UK, Netherlands, Poland, Belgium and Lithuania.

LNG RECEIVING AND REGASIFICATION TERMINALS

The fourth step in the LNG process chain involves the import terminals, which are marine or waterfront facilities. LNG carriers deliver the LNG to a marine terminal where the LNG is stored before undergoing regasification, which converts the LNG back into its gaseous form.

In 2018, about 148 LNG import terminals (regasification plants) operated worldwide. The largest importers of LNG are Japan, China, South Korea, India and Taiwan on the Asian continent, Mexico, Brazil, Argentina and Chile in the Americas, Kuwait and Jordan in the Middle East and a number of European countries such as Turkey, France, the UK, Portugal Italy, Spain and the Netherlands. An overview of exporting and importing countries throughout the world is illustrated in **Figure 5**.

LNG can also be delivered to floating terminals which are LNG ships or barges constructed to function as Floating Storage Units (FSU), Floating Regasification Units (FRU) or Floating Storage and Regasification Units (FSRU). Floating facilities allow LNG terminals to be sited offshore and deployed rapidly, often at a lower capital cost than conventional terminals. Floating terminals are operating in Argentina, Brazil, China, Colombia, Egypt, Indonesia, Israel, Italy, Jamaica, Jordan, Kuwait, Lithuania, Malaysia, Malta, Pakistan, Turkey, UAE and the US.

Another type of facility which may receive LNG by ship is known as a peak-shaving facility. These plants, which may be operated by utility companies, store LNG in tanks until it is needed at times of peak demand. An LNG peak-shaving facility is normally connected to the gas supply system and may consist of LNG liquefaction equipment to convert the natural gas into LNG, LNG storage tank(s), pumps, vaporisers and other equipment to turn the LNG back from a liquid to natural gas. In some cases peak-shaving facilities are filled using road tankers from an import terminal. There are different designs of LNG import terminals but the overall process is often quite similar.

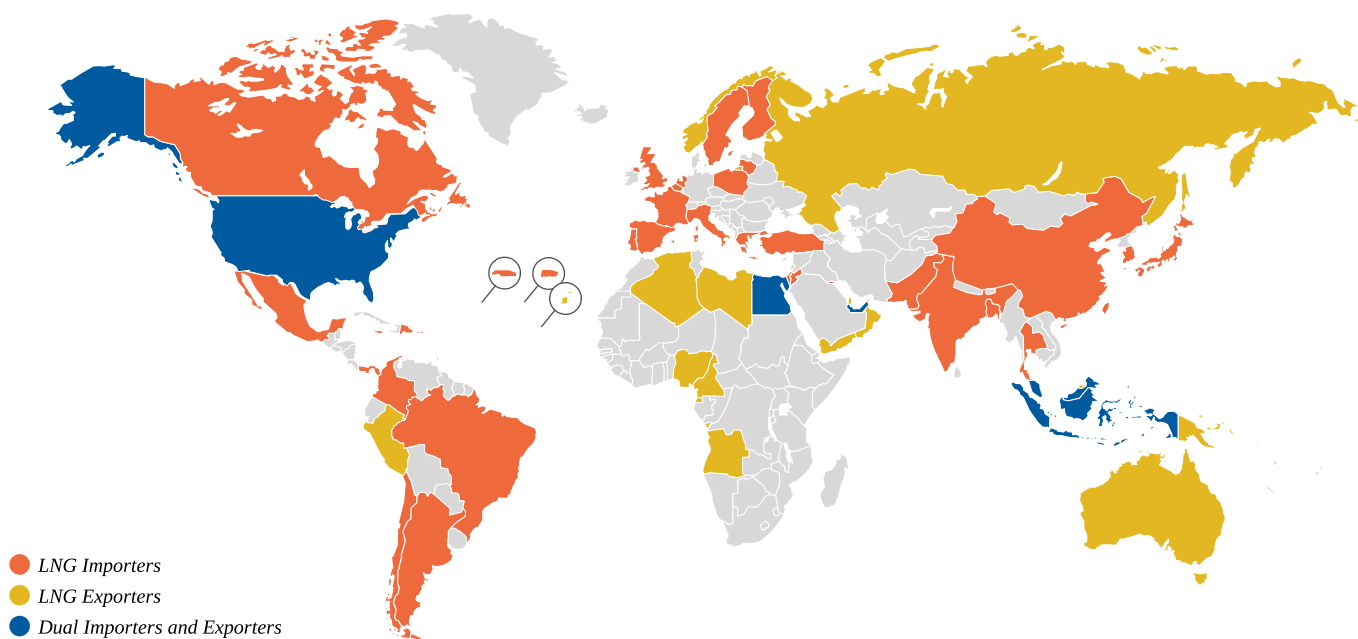

Figure 5. Overview of LNG exporting and importing countries (Source: GIIGNL, 2018)



A typical LNG import terminal process flow diagram is shown in **Figure 6**. The major equipment components of an LNG import and regasification terminal are:

- Unloading arms,
- Cryogenic pipelines,
- Storage tank(s),
- Low pressure pumps,
- Boil-Off Gas (BOG) compressors and re-condensers,
- High pressure (HP) pumps, and
- Vaporisers.

Boil-off gas is the vapour produced above the surface of a boiling cargo due to evaporation, which is caused by heat ingress or a drop in pressure.

Since natural gas is odourless, odourisation of the re-gasified natural gas is required in many regions and countries before it is distributed to consumers. A typical odorant is THT (tetrahydrothiophene) or mercaptan.

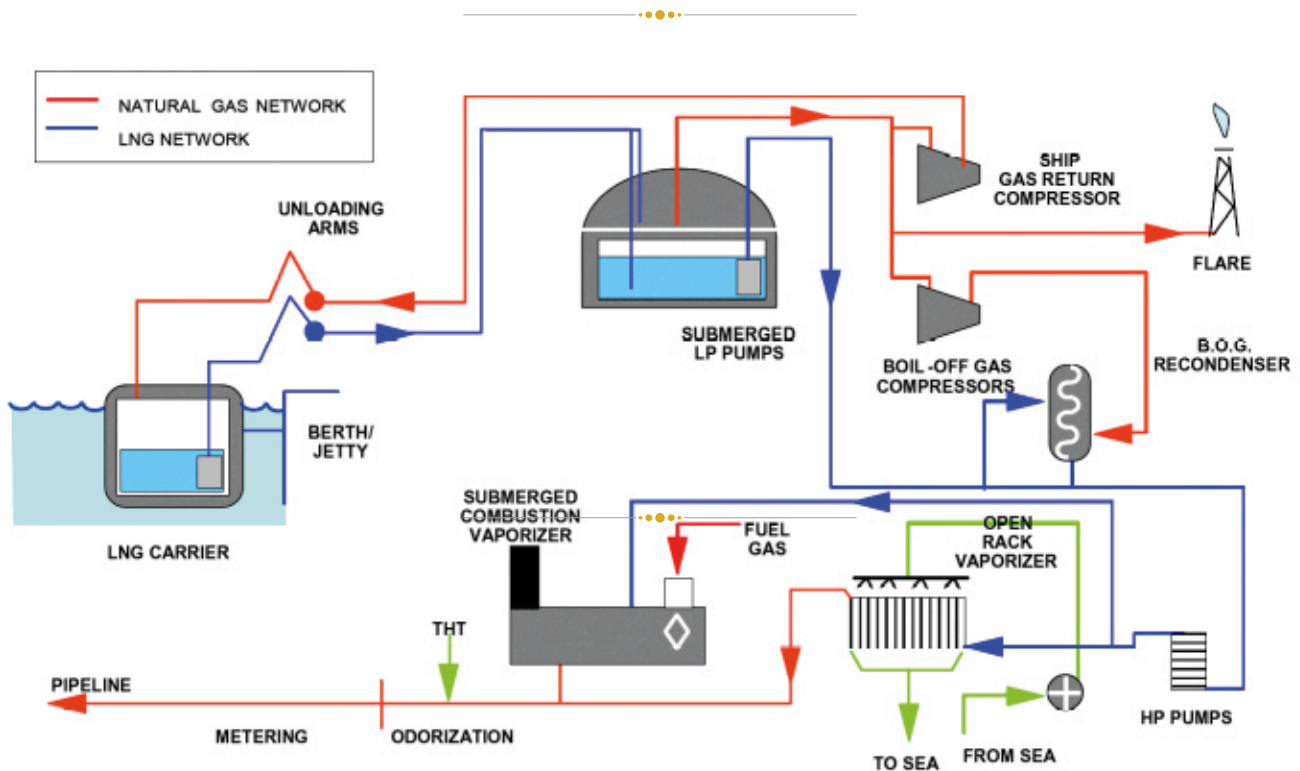

Figure 6. Example of LNG import terminal process (Source: BV 2009)

(Un)loading

LNG (un)loading operations use articulated arms or cryogenic flexible hoses, which are specifically designed to transfer cargo safely from the ship to the terminal. The articulated arms are called “hard-arms” and are the connection between the ship’s manifold system (piping connection) and the terminal. A picture of hard-arms connecting the ship and terminal is shown in **Figure 7**.

Flexible hoses are often used for Ship-to-Ship transfers such as loading operations with FSRUs or between two LNG carriers for cargo trading. Additionally, small scale LNG transfers, such as from trucks, from bunkering or transport vessels, often rely on flexible cryogenic hoses.

Once the LNG carrier is moored, the (un)loading arms/hoses are gradually chilled to approximately -162°C (-259°F) prior to the beginning of LNG unloading opera-



Figure 7. Unloading arms at an import (receiving) terminal (Source: BV 2009)



tions. The (un)loading arms/hoses are able to endure the expansion and contraction which results from changes in temperature.

Most unloading installations are fitted with an emergency disconnection system (known as a Powered Emergency Release Coupling or PERC) that protects the ship’s manifold connection and terminal’s hard arms/hoses from damage in the event of large movement of the LNGCs during unloading.

This system allows the rapid disconnection of the LNG carrier from the terminal while limiting the amount of LNG which could potentially be released. Position detectors are installed to check that the ship is not moving too vigorously (in a manner likely to break the arms). These detectors can activate the emergency disconnection system. The PERC is comprised of two ball valves and an emergency release coupler. If the vessel moves outside of the normal operating range, an ESD (emergency shutdown device) will be activated automatically and cargo transfer will be stopped. Further movement of the vessel outside of the operating range will activate the emergency release system. The ball valves will close and the emergency release coupler will operate. One ball valve remains attached to the ship and the other stays attached to the arm/flexible. The PERC system may also be activated by an operator. This system is designed to trap the minimum amount between the valves which could be spilled upon release.

Flexible hoses and arms are also used for ship LNG re-loading from onshore storage tanks

Storage

After unloading, LNG is transferred via cryogenic pipelines to insulated storage tanks specifically built to hold LNG.

There are three kinds of facilities where LNG can be stored: onshore import terminals, floating import terminals and peak-shaving facilities.

LNG storage tanks are designed to withstand cryogenic temperatures, maintain the liquid at low temperature, and minimize the amount of evaporation. The small part of LNG which evaporates is called “boil-off gas”. The temperature within the tank will remain constant if the pressure is kept constant by allowing the boil-off gas to escape from the tank. This gas is captured and: a) re-condensed to be sent to the vaporiser with LNG or compressed and sent to the pipeline; or b) re-injected into the LNG carrier to maintain positive pressure during the unloading of the ship; or c) only in abnormal or accidental situations, sent to the flare. For pressurized LNG tanks, the boil-off gas is suppressed by allowing the tank pressure to increase.

The storage facility is designed with a venting feature as an ultimate protection against risk of overpressure due to a “roll-over” condition in the LNG tank. LNG “rollover” refers to the rapid release of LNG vapours from a storage

tank, resulting from stratification. The potential for rollover arises when two stratified layers of different densities (due to different LNG compositions) exist in a tank. To prevent rollover, top & bottom filling lines as well as special instruments called densitometers are used to monitor the development of the layers within the tank and allow the operator to mix the LNG within the tank or with that in other tanks to break up the stratification.

An import terminal usually has two or more LNG storage tanks. The types of tank types, described further in Information Paper No. 5, are:

- Single containment tanks,
- Double containment tanks,
- Full containment tanks,
- Pressurized small tanks,
- Membrane tanks, and
- In-ground tanks.

Re-gasification

Next, the LNG stored in the tanks is sent to vaporisers which warm and regasify the LNG. As this occurs, boil-off gas evaporating from the LNG stored in the tanks is re-condensed, and also sent to the vaporisers. This will avoid flaring or venting boil-off gas for most operating conditions.

The main types of vaporisers used in the LNG industry are Open Rack Vaporisers, Submerged Combustion Vaporisers, Intermediate Fluid Vaporisers and Ambient Air Vaporisers.

Open Rack Vaporisers (ORV)

Open Rack Vaporisers (Figure 8) derive the heat necessary to vaporise LNG from seawater. The water is first filtered to avoid the presence of small solid particles in the ORV. It then falls onto panels of tubes containing LNG and then gathers in a trough underneath before being discharged back into the sea. The LNG passing through the tubes is heated and vaporises.

The tubes are specifically designed to optimise heat exchange.

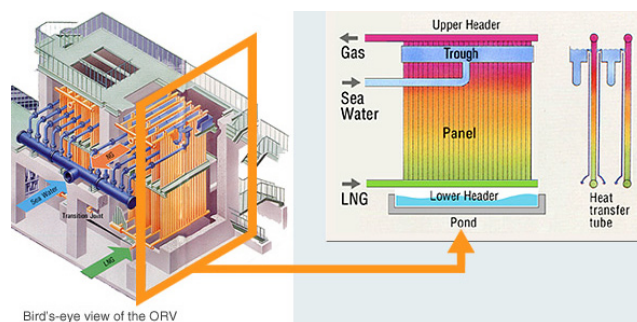

Figure 8. Open rack vaporiser (Source: Tokyo gas)



Submerged Combustion Vaporisers (SCV)

Submerged Combustion Vaporisers burn natural gas produced by the terminal and pass the hot gases into a water bath containing a tubular heat exchanger where LNG flows (Figure 9). The froth produced by the combustion gas increases the efficiency of heat transfer between the water and the LNG, and prevents ice from forming on the tube bundle. Submerged Combustion Vaporisers burn 1 to 1.5 % of the natural gas processed.

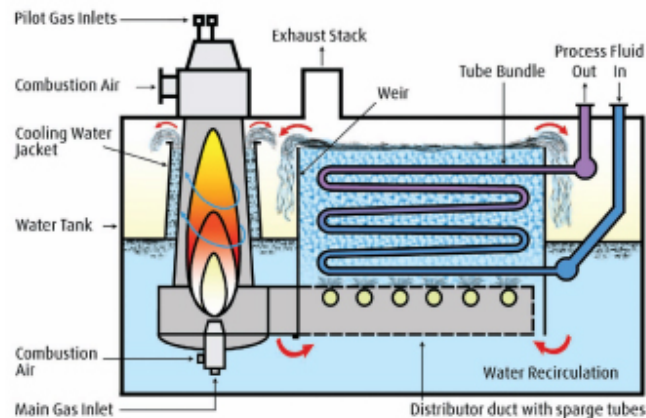

Figure 9. Submerged Combustion Vaporiser (Source: Selas Fluid Processing Corporation brochure)

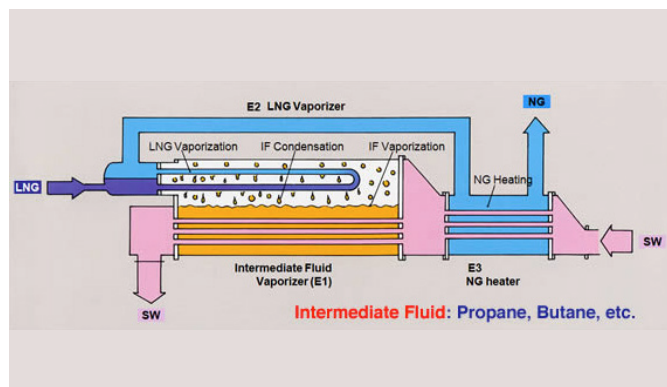

Figure 10.a) Integrated Intermediate Fluid Vaporise (Source: KOBELCO)

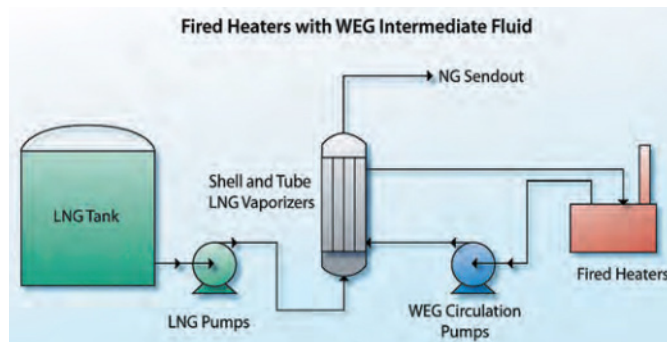

Figure 10.b) S&T vaporisers with an intermediate loop (Source: LNG Journal, 2006)

Ambient Air Vaporisers (AAV)

This vaporiser uses the heat from the air. It is a proven technology and has generally been used for smaller installations such as LNG satellite terminals fed with LNG by road truck (Figure 11). The units may have natural convection or fan-assisted air flow. Some larger units have recently been installed at LNG import terminals where seawater systems are considered unsuitable.



Figure 11. Ambient Air Vaporiser (Source: BV 2009)

Odourisation, Send-out, and Delivery

Before natural gas is distributed to consumers, an unpleasant-smelling odour is added. Because natural gas is colourless and odourless, a leak is impossible to detect without appropriate instruments. To make the detection of a gas leak easier, whether it is in our kitchen or in a pipeline, an odorant is normally added to natural gas. The odorisation station can be in the LNG terminal itself before the send-out of natural gas, or just a few kilometers beyond the terminal. The point at which odorants are added depends on the country. Many terminals that export to a high pressure transmission line do not odorise.

Metering, the last step at the terminal, measures the quantity of gas which is being sent out. Natural gas is then delivered by pipeline directly to customers for industrial or residential use.

LNG Reloading

LNG reloading means loading back an already discharged LNG cargo onto a vessel for the purpose of re-export. In 2018, a total 3.8 MT of LNG was reloaded worldwide, 2.9 MT of which from Europe. Reloading of LNG has become very common recently in the European LNG market to take advantage of price differentials between markets.



KEY POINTS AND CONCLUSIONS

In closing, the key points of this information paper are:

1. The LNG Process Chain includes the Extraction, Processing, Liquefaction, Transport, Storage, Regasification and distribution to consumers of LNG.
2. Extraction of natural gas from commercially-viable, drilled wells produces “feed gas” which needs to be processed to commercial quality.
3. Processing of LNG includes cleaning it by separating and removing various extraneous compounds, including carbon dioxide and water.
4. Liquefaction of the natural gas, predominantly methane, is achieved by refrigeration down to approximately -162°C (-259°F).
5. Transport of LNG over long distances is by sea in specially-designed, double-hulled LNG ships, or over shorter distances by specialized, double-skinned tank trucks or small LNG carriers. Once LNG is regasified, natural gas is sent out to consumers through a pipeline distribution network.
6. LNG is delivered to three kinds of facilities: onshore import terminals, floating import terminals and peak-shaving facilities. LNG is unloaded using cryogenic unloading arms or hoses and transferred via pipelines to specifically-designed, insulated storage tanks at these facilities.
7. LNG unloading operations in import terminals use articulated arms (“hard-arms”) or cryogenic flexible hoses specifically-designed to safely transfer the LNG safely from the ship to the terminal.
8. Safety systems are designed into every single step of the “Chain”. Examples include, during the Unloading Process, the Power Emergency Release Coupler (PERC), which safely disconnects the ship’s manifold connection and the terminal’s hard-arms in emergency situations, and Emergency Shutdown Systems (ESDs), which immediately terminate the loading process with no leakage. These activate either automatically or manually.
9. Regasification of the LNG is accomplished by using one of a number of kinds of vaporizers.
10. Odors are added after regasification, then the natural gas is metered and sent out for delivery to the ultimate industrial or residential customers through a pipeline.

The excellent safety record for the LNG Process Chain is a result of the LNG industry’s stringent design practices and diligent operating standards, enhanced and supported by strong regulatory oversight. In that specific regard, a graphic illustration of these “Multiple Safety Layers” is reflected in the figure below. Subsequent papers in this

series will include a discussion of the many ways in which LNG safety is assured, through Multiple Safety Layers, all firmly based on a foundation of solid Industry Standards, Regulatory Compliance and Codes. These “safety layers” include several key components of the industry’s Risk Management framework. Included among them are Primary and Secondary Containment, Control Systems which promote Operational Integrity; Protocols, Operator Knowledge and Experience (which are reinforced by comprehensive and ongoing training). A protective umbrella of Safeguard Systems, Separation Distances, and Contingency Planning further enhances safe management of LNG.

Multiple Safety Layers Manage LNG Risk

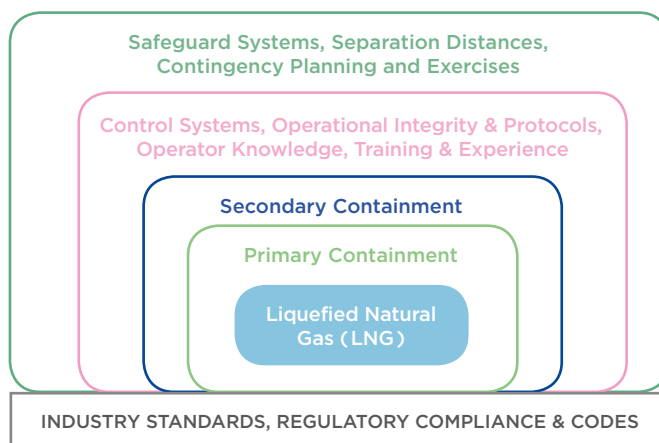

For more information about these and other topics, or to obtain copies of this report series contact:

GIIGNL
 8 rue de l’Hôtel de Ville
 92200 Neuilly-sur-Seine (France)
 Telephone: +33 (0)1 56 65 51 60 Email: central-office@giignl.org
 Web address: <https://giignl.org>